



SWIMMING POOL ENCLOSURES, SHUTTERS AND COVERS BIOCLIMATIC PERGOLAS



WELCOME TO AZENCO PRO

Azenco PRO, your swimming pool enclosure and shutter specialist, is part of the Akena group, one of the largest French manufacturers of verandas and pergolas in France. Today, Azenco PRO offers a wide range of innovative, high-quality products to meet all your customers' expectations.

A brand new offer, created by combining the very best of Azenco pool enclosures, JM Cover pool covers and shutters and Soko pergolas and verandas.

A single brand working with you to provide expertise, services, advice, responsiveness and proximity to your customers for their outdoor design projects.



ALL THE STRENGTHS OF A LEADING OUT-DOOR GROUP

A group of 200 professionals to provide you with a wealth of experience and expertise. All our products are manufactured in one of our 4 French factories and are transported via 2 logistic platforms.

100% Made in France, combining technicality and reliability, using high-quality, durable materials that meet the most stringent standards, everything to guarantee the best solutions for your customers.

Innovation and design are very much a part of our DNA, and our Design Office is constantly developing new ways to improve our products and ensure our customers' satisfaction.



Our factories

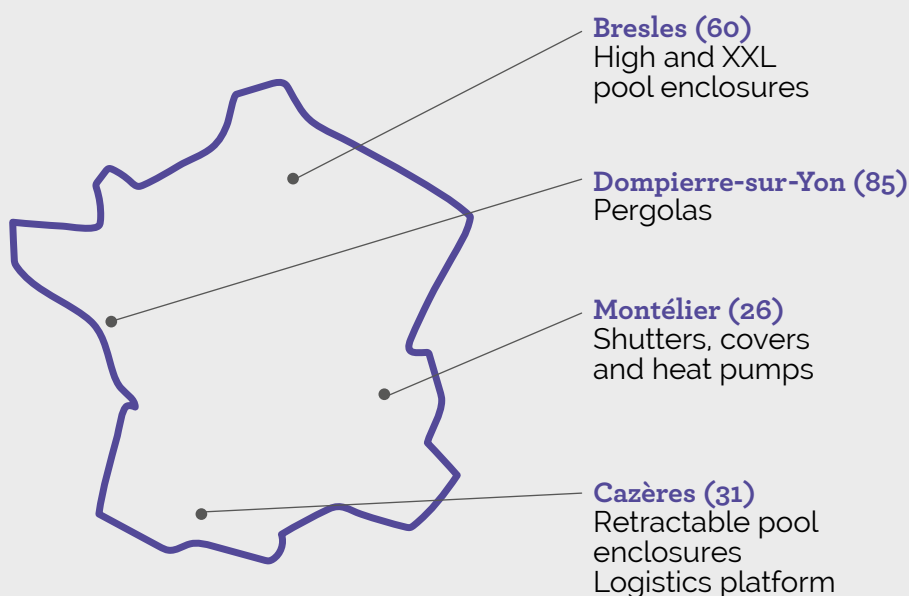

Ten-year guarantee
(for high enclosures)



QualiMarine Label



Proabris Label

A PERSONALISED APPROACH, FROM A TO Z

Our team of professionals is here for you every step of the way:

1 **A dedicated** contact person when you open your account.

2 **Technical visit** to validate the project.

3 **Order confirmation** and delivery time communicated within 48 hours.

4 **Production** supervised by our Design Office.

5 **Schedule** the delivery date.

6 **Delivery** directly on site.



You will also benefit from a dedicated contact person who will assist you with your project; everything from registering your orders and answering technical questions to helping with administrative formalities and after-sales support.

Contents

THE WORLD OF SWIMMING POOLS

COVERS	P.7
Bar covers	P.8
Covers with straps	P.11
WINTER COVERS	P.12
Winter covers	P.13
Opaque covers	P.16
SUMMER COVERS	P.19
Bubble covers	P.20
POOL SHUTTERS	P.22
Silver Roll shutter	P.23
Mouv & Roll shutter	P.24
Underwater shutter	P.25
Total underwater shutter	P.26
SWIMMING POOL ENCLOSURES	P.27
Flat pool enclosures	P.28
Low pool enclosures	P.29
Medium pool enclosures	P.34
High pool enclosures	P.35
Sliding patios	P.38
HEAT PUMPS	P.39
OUTDOOR	
PERGOLAS	P.43
Bioclimatic pergola with adjustable slats	P.44
Bioclimatic pergola with opening roof	P.45
Bioclimatic pergola with variable tint fixed roof	P.46
CARPORTS	P.47
Carports	P.48
ACCESSORIES	P.49



The world of swimming pools

Covers



SÉCU CLASSIC



Equipped with an anti-lift system that fully protects the pool.



View the complete technical data sheet

Features

- All-season cover.
- Easy opening and closing.
- Finished with hems on the sides and lengthwise anti-lift straps.
- 50 cm overhang, i.e. 25 cm all around.
- Equipped with Ø 45mm / 2mm thick aluminium bars spaced at 1.30m (average) to a maximum of 1.50m apart.
- The bars sit on the paving/pool edge.
- Compact (max. rolled up diameter: 30 cm).
- Roll-up using minimum effort manual crank handle (supplied).
- Roll-up and storage bars integrated in the hems to ensure maximum tension in the cover.
- Roll-up square drive: male 13 x 13 mm.
- Unroll using unrolling strap.
- Rainwater drainage holes.

PVC - 580g/m²
 With anti-UV and anti-mold treatments
 Maximum width inside the pool: 5.30 m (transport limit). Up to 13m long.

COLOURS

	Beige		Anthracite
	Almond		Blue
	Green		Grey

Accessories supplied with the cover

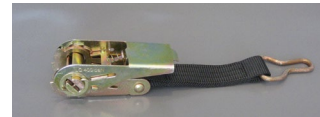

Ratchet with attachment loop



Retractable pins



V bungee cord with flat attachment end (for steps laid out lengthways)



Minimum effort manual crank handle



Straps



Runners under the bars

Available options

- + Wooden decking pins.
- + Anti-abrasion strips to protect the PVC fabric from wear and tear from the edges/paving.
- + Rolling-Up: motorised crank handle.
- + Load bar: allows you to use a cover with steps along the length.
- + Can be cut to size for ladders and filter blocks; please ask for a quotation.
- + Stainless steel accessories: upon request.

Pricing

Depending on the length and width chosen.

Maximum dimensions inside the pool: 5.30 x 12.5 m. If the width exceeds 5.80 m (including overhangs), a transport surcharge will be applied.



SÉCU BASIC



Basic model delivered without hems or straps along the length of the cover.



View the complete technical data sheet

Features

- All-season cover
- Easy opening and closing.
- 50 cm overhang, i.e. 25 cm all around.
- Equipped with Ø 45mm / 2mm thick aluminium bars spaced at 1.30m (average) to a maximum of 1.50m apart.
- The bars sit on the paving/pool edge.
- Compact (max. rolled up diameter: 30 cm).
- Roll-up using minimum effort manual crank handle.
- Roll-up and storage bars integrated in the hems to ensure maximum tension in the cover.
- Roll-up square drive: male 13 x 13 mm.
- Unroll using unrolling strap.
- Rainwater drainage holes.

PVC - 580g/m²
With anti-UV and anti-mold treatments
Maximum dimensions inside the pool:
5.30 x 12.5 m

COLOURS

	Beige		Anthracite
	Almond		Blue
	Green		Grey

Accessories supplied with the cover

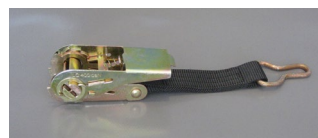

Ratchet with attachment loop



Retractable pins



V bungee cord with flat attachment end (for steps)



Minimum effort manual crank handle

Available options

- + Wooden decking pins.
- + Anti-abrasion strips to protect the PVC fabric from wear and tear from the edges/paving.
- + Load bar: allows you to use a cover with steps along the length.
- + Can be cut to size for ladders and filter blocks; please ask for a quotation.
- + Rolling-Up: motorised crank handle.
- + Stainless steel accessories: upon request.

Pricing

Depending on the length and width chosen.

Maximum dimensions inside the pool: 5.30 x 11 m.
If the width exceeds 5.80 m (including overhangs), a transport surcharge will be applied.

Width + 0.50 m
× Width + 0.50 m
× Price per m² excl. VAT

COVERWOOD



Cover for above-ground swimming pools.









View the complete technical data sheet

Features

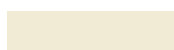
- All-season cover.
- Easy opening and closing.
- Finished with hems on lengths and anti-lift bungees between each bar.
- Equipped with Ø 45mm / 2mm thick aluminium bars spaced at 1.30m (average) to a maximum of 1.50m apart.
- The bars sit on the paving/pool edge.
- Compact (max. rolled up diameter: 30 cm).
- Supplied with a handwheel for rolling with 13 mm female square drive.
- Roll-up and storage bars integrated in the hems to ensure maximum tension in the cover.
- Roll-up square drive: male 13 x 13 mm.
- Unroll using unrolling strap.
- Screws not included.

PVC - 580g/m²
 With anti-UV and anti-mold treatments
 Maximum width inside the pool: 4.30 m.

COLOURS

	Beige		Anthracite
	Almond		Blue
	Green		Grey

Accessories supplied with the cover



Ratchet with attachment loop



Plastic hooks (to attach the bungees)



Crank handle

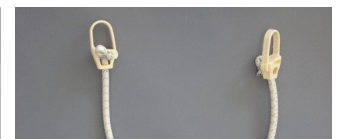

V bungee



Stainless steel hooks for ratchets

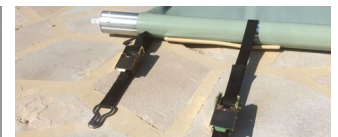

Storage Straps

Available options

- + Anti-abrasion strips to protect the PVC fabric from wear and tear from the edges/paving.
- + Wooden decking pins.
- + Can be cut to size for ladders and filter blocks; please ask for a quotation.
- + Stainless steel accessories: upon request.
- + Can be cut to size.

Pricing

Price calculated depending on the width and length entered (with minimum / maximum).



SÉCU +



Suitable for large pools (up to 6x12m) and provides excellent safety and protection all year round.



View the complete technical data sheet

Features

- Easy opening and closing.
- Anti-lift and anti-intrusion thanks to the lengthwise straps.
- Lengthwise straps tightened with ratchet tensioners and Ø50 mm anodised tubes fitted into the two reinforced hems at the ends of the cover.
- 70 cm overhang, i.e. 35 cm all around.
- Compact (max. rolled up diameter: 30 cm).
- Roll-up using minimum effort manual crank handle (supplied).
- Roll-up and storage bars integrated in the hems to ensure maximum tension in the cover.
- Roll-up square drive: male 13 x 13 mm.
- Unroll using unrolling strap.
- Rainwater drainage holes.

PVC - 580g/m²
 With anti-UV and anti-mold treatments
 Maximum pool size: 6.20m.
 Please ask for a quote for transport costs.

COLOURS

	Beige		Anthracite
	Almond		Blue
	Green		Grey

Accessories supplied with the cover



Ratchet with attachment loop

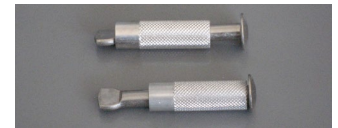

Retractable pins



Minimum effort manual crank handle



Tensioner springs



Straps

Available options

- + Anti-abrasion strips to protect the PVC fabric from wear and tear from the edges/paving.
- + Load bar: allows you to use a cover with steps along the length.
- + Wooden decking pins.
- + Can be cut to size for ladders and filter blocks; please ask for a quotation.
- + Rolling-Up: motorised crank handle.

Pricing

The price is calculated based on the width and length of the area of water.
 The minimum invoiced surface area is 1m².

WATER SURFACE AREA
Length + 0.70 m
× Width + 0.70 m
× Price per m² excl. VAT

Winter covers



SÉCURITIS



*Excellent protection for your pool during winter.
Protect your pool from the elements.*



View the complete technical data sheet

Features

- Replaces the safety covers.
- Secured using stainless steel retractable pins and V bungee cords with safety-approved attachment ends.
- Prevents photosynthesis.
- Reduces the need for treatment products.
- Reduces the time it takes to get your pool back up and running in spring.
- Welded seams.
- Protective reinforcement at both ends of the cover.
- 70 cm overhang, i.e. 35 cm all around.
- Eyelets approx. every 80 cm.
- No maximum length.
- Rainwater drainage mesh.

PVC - 580g/m²
With anti-UV and anti-mold treatments
Cover: PVC 280 gr/m²
Maximum width inside the pool: 6 m

PVC COLOURS

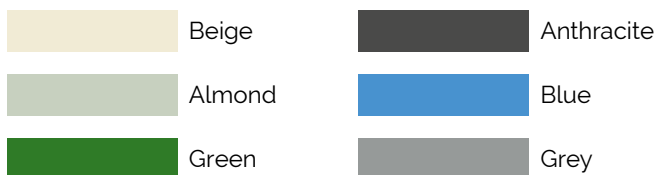

Accessories supplied with the cover



V bungee cord with flat attachment end (for steps)



Retractable pins

Available options

- + Wooden decking pins.
- + Can be cut to size for steps/ladders/filter.

Pricing

The price is calculated based on the width and length.
The minimum invoiced surface area is 1m².

WATER SURFACE AREA
Length + 0.70 m
× Width + 0.70 m
× Price per m² excl. VAT

MESH COLOURS



SÉCURITIS ECO



Stylish winter cover that protects your pool and reduces the time it takes to get it back up and running in the spring.



View the complete technical data sheet

Accessories supplied with the cover

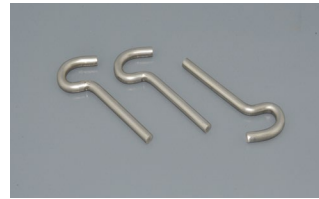

Ground pegs



V bungee

Features

- Replaces the safety covers.
- Secured with safety-approved stainless steel ground pegs and bungees.
- Prevents photosynthesis.
- Reduces the need for treatment products.
- Reduces the time it takes to get your pool back up and running in spring.
- Welded seams.
- Protective reinforcement at both ends of the cover.
- 70 cm overhang, i.e. 35 cm all around.
- No maximum length.
- Rainwater drainage mesh.

PVC - 580g/m²
With anti-UV and anti-mold treatments
Maximum width inside the pool: 6 m

PVC COLOURS

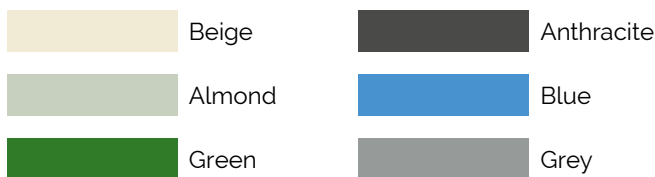

Available options

- + Wooden decking pins.
- + Can be cut to size for steps/ladders/filter.

Pricing

The price is calculated based on the width and length of the area of water.
The minimum invoiced surface area is 1m².

WATER SURFACE
AREA Length + 0.70 m
× Width + 0.70 m
× Price per m² excl. VAT

MESH COLOURS



SÉCURITIS ABOVE- GROUND



Specially adapted for above-ground pools thanks to its safety-approved plastic hook and bungee cord fixing system.



View the complete technical data sheet

Accessories supplied with the cover



Plastic hooks



V bungee

Features

- Secured with safety-approved stainless steel ground pegs and bungees.
- Welded seams.
- Protective reinforcement at both ends of the cover.
- Overhang of 10 cm in relation to the outer edge of the pool.
- No maximum length.
- Rainwater drainage holes.
- Screws not included.

PVC - 580g/m²

With anti-UV and anti-mold treatments

Maximum width inside the pool: 4.30 m

The pool must be at least 40 cm above ground to enable the cover to be secured with bungee cords

PVC COLOURS

	Beige		Anthracite
	Almond		Blue
	Green		Grey

Available options

- + Ladder cut-out.

Pricing

The price is calculated based on the external width and length.

The minimum invoiced surface area is 1m².

To make sure that the cover will fit properly, please provide the outside dimensions of the poolside paving stones when ordering.

Length outside + 0.20 m

× Width outside + 0.20 m

× Price per m² excl. VAT

COVER



Opaque cover to protect your swimming pool and water during the winter.



View the complete technical data sheet

Features

- PVC 580 g/m².
- Welded seams.
- Reinforced hem.
- 70 cm overhang, i.e. 35 cm all around.
- This cover is not approved as a safety cover.

PVC COLOURS

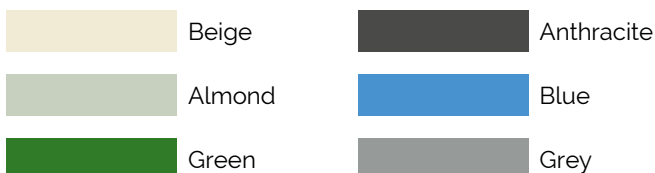

MESH COLOURS

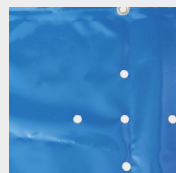

COVER 1

- Rainwater drainage holes.
- Secured with stainless steel ground pegs and outer edge bungee cord.



COVER 2

- Rainwater drainage mesh.
- Secured with stainless steel ground pegs and outer edge bungee cord.

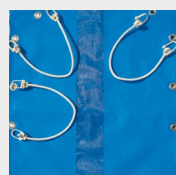

COVER 3

- Rainwater drainage mesh.
- Secured with stainless steel ground pegs and V bungee cords.

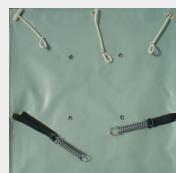

COVER 4

- Rainwater drainage holes.
- Secured with heavy-duty polyester straps and tensioner springs along the lengths and cabiclic bungee cords along the widths.

Accessories supplied with the cover



Ground pegs

RECYCLABLE COVER

(WINTER) SPECIAL DESIGN FOR ABOVE-GROUND WOOD AND ALUMINIUM POOL



This extremely resistant cover protects your pool and makes it easier to maintain.

For wood/aluminium pools - Polyethylene 200 g/m² - With anti-UV treatment

COLOURS



Features

- Limits dirt, keeps the pool clean and prevents the growth of algae.
- Reduces the need for treatment products.
- This lightweight cover is easy to fit and can withstand wind speeds of up to 50km/h.
- This cover is not approved as a safety cover.

Accessories supplied with the cover



Ground pegs



Outer edge bungee cord

"GR" MODELS



Protects the pool from dirt by trapping debris and preventing it from falling into the pool. This protects the pool and helps keep the water clean.



View the complete technical data sheet

Features

- Protects your pool from the elements.
- Reduces the time it takes to get your pool back up and running in spring.
- Welded seams.
- Reinforced PVC hem.
- 70 cm overhang, i.e. 35 cm all around.

PVC - 280g/m²
With anti-UV and anti-mold treatments

COLOURS

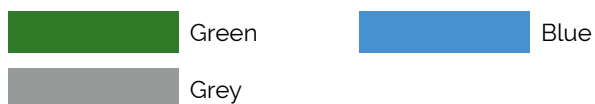

GR
➤ Secured with stainless steel ground pegs and outer edge bungee cord.



GR 3
➤ Secured with stainless steel ground pegs and V bungee cords.



GR +
➤ Secured with heavy-duty polyester straps and tensioner springs along the lengths and cabiclic bungee cords along the widths.

Accessories supplied with the cover

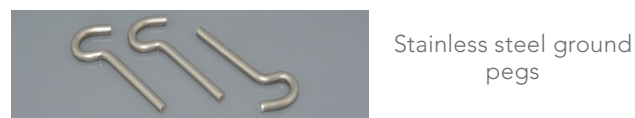

“GR VOL” MODELS FOR USE WITH SHUTTERS



Features

- Protects your pool from the elements.
- Lightweight and quick and easy to fit.
- Can be cut out around the roller feet.
- Welded seams.
- Reinforced PVC hem.
- 80 cm overhang, i.e. 40 cm all around.
- Strap in the hem, 10 retractable pins + 4 tensioning ratchets.
- Min. 2 cabiclic bungees.



View the complete technical data sheet

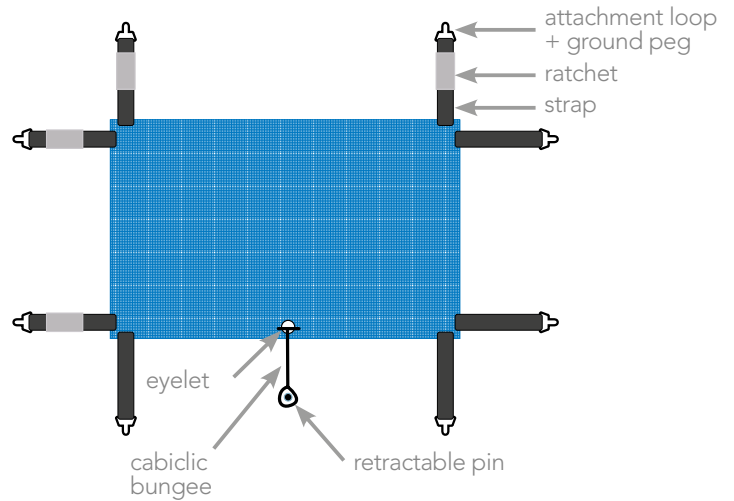

PVC - 280g/m²
With anti-UV and anti-mold treatments

COLOURS

- Green
- Blue
- Grey



Summer covers



BUBBLE COVERS

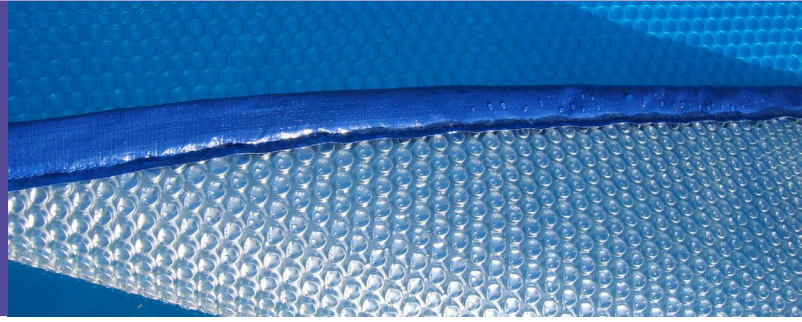

Perfect for the summer period, bubble covers limit heat loss during the night and have a wide range of advantages depending on the model.



View the complete technical data sheet

Available options

- + Leaf collector.
- + Separate protective cover.
- + Securing straps.

Features

- Limits dirt, keeps the pool clean and prevents the growth of algae.
- Lightweight and easy to fit and remove.
- Wind-resistant.
- Absorbs solar energy and keeps the heat in the pool.
- Reduces water evaporation.
- Available in a variety of colours.

Pricing

The price is calculated based on the internal width and length.

The minimum invoiced surface area is 1m².

Finishes

- 4 hemmed edges, 2 hemmed edges no hemmed edges with stainless steel eyelets.
- 400 micron rolls, 4 or 5m wide.

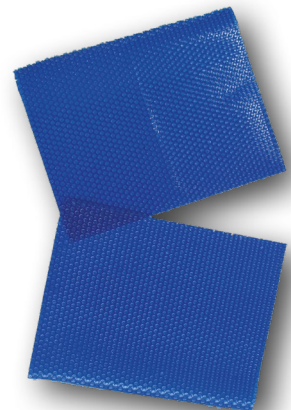
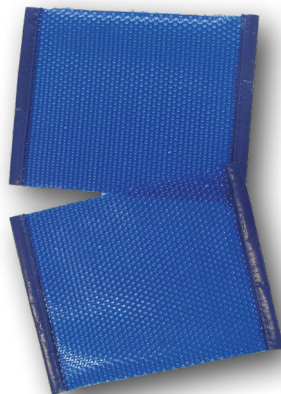
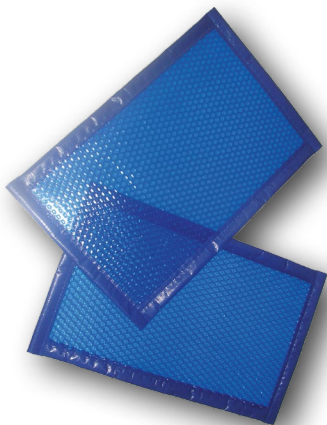

Classic Models

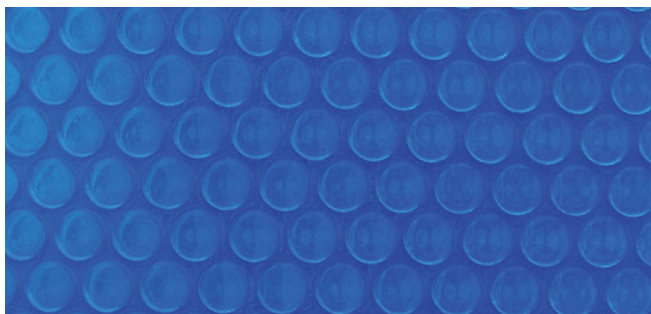

Blue / blue 400 or 500 microns.

High-quality, classic covers at a competitive price. Heats the pool by 2 to 4°C. Ø12 mm bubbles.

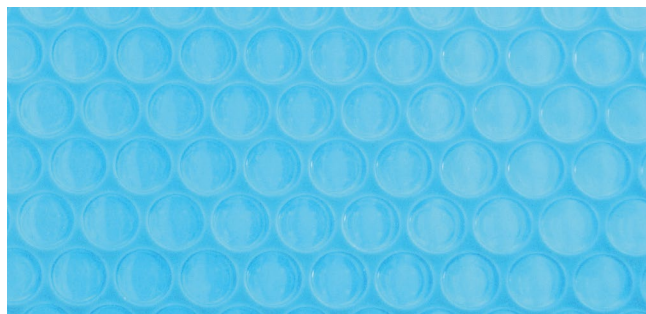

Translucent - 400 microns.

An innovative model with a colour that blends in with the water and provides 8°C more heat. Ø12 mm bubbles.

Double bubble models

- More resistant to ageing since the material is 50% thicker at the weakest points.
- This special design eliminates the constraints of the "classic" bubble cover.
- Better resistance to air expansion.
- Reduces the effects of UV and chemicals thanks to its smooth shape and even thickness.



Sol+ Guard - 500 microns.

Retains heat accumulated during the day. Reduces the need for chemicals. Heating capacity: up to 8°C.

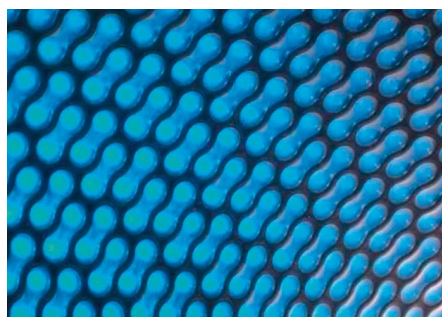

Solibul - 500 microns.

Absorbs and transmits the sun's rays to increase the water temperature while preventing the growth of algae. Prevents photosynthesis.

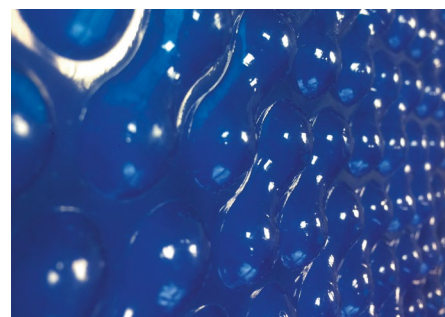

Duobul blue/blue - 500 microns.

Retains heat accumulated during the day. Reduces the need for chemicals. Heating capacity: up to 8°C.

Pool shutters



SILVER ROLL SHUTTER



An extremely functional model, designed for pools of all shapes and sizes and very easy to use.



View the complete technical data sheet

Features

- Installed at the edge of the pool on the paving/decking.
- Easy opening and closing with the turn of a key.
- Keeps the pool safe and secure.
- Limits dirt, keeps the pool clean and prevents the growth of algae.
- Limits evaporation and reduces the need for chemicals and water treatment products.
- Allows you to use your pool for longer.
- Stylish and discreet.
- Frees up space around the pool.
- Also available in large widths (up to 8 m wide).

Technical specifications

- 80, 120 or 200 Nm drive motor located in the tube with integrated limit switch.
- Ø 140 tube.
- For widths over 6 m and up to 8 m, you should use the X-Trem Roll structure with a Ø 200 tube.

DIMENSIONS

- Minimum width: 3m / maximum width: 8m
- Slats: 1.7 cm thick.
- Maximum water surface area: 98 m2.

Opaque, waterproof, interlocking PVC slats
Motorised anodised aluminium tube - 140

FEET COLOURS



END CAP COLOURS (polycarbonate only)

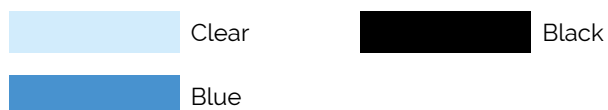

Available options

- 24 V solar power supply on a swivel stand.
- Anthracite coloured feet available as an option (RAL7022).
- Chlorinator option with shutter contact: electric control unit and chlorinator control.
- OXEO contactless chlorinator option.
- Can be cut to size for steps (square or smooth finish).
- Solar or clear polycarbonate slats.
- Can be cut to size for filter blocks.
- Optional poolside safety strap loop.
- Remote control opening/closing or via Bluetooth system.
- GR VOL anti-leaf net (available in: grey, blue or green).
- Motor clutch.
- Easy plug.

Examples of finishes

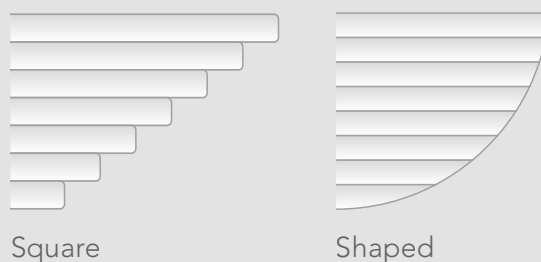

PVC BLADE COLOURS (3-year guarantee)



POLYCARBONATE SLAT COLOURS (5-year guarantee)



NB: Clear polycarbonate slats are for indoor use only. The blue and black slats heat the water. Grey slats do not heat the water.

MOUV & ROLL SHUTTER



Its flexible structure & guide rails means that it can cover and secure a wide range of swimming pools.



View the complete technical data sheet

Features

- Extremely flexible.
- Limits dirt, keeps the pool clean and prevents the growth of algae.
- Stylish, adaptable, safe and discreet.
- Easy to install.
- Suitable for all pool shapes.
- Positioned at the end of the pool.
- Thanks to the guide rail, it can be fully retracted to free up space around the pool.

Technical specifications

- 80 or 200 Nm drive motor located in the tube with integrated limit switch.
- 3-position key switch.

DIMENSIONS

- Minimum width: 3m / maximum width: 6.20m.
- Slats: 1.7 cm thick.
- Maximum water surface area: 6.20 x 12 m and 98 m².

Opaque, waterproof, interlocking PVC slats
 Motorised anodised aluminium tube - 140
 Aluminium powder-coated feet

FEET COLOURS



END CAP COLOURS (polycarbonate only)

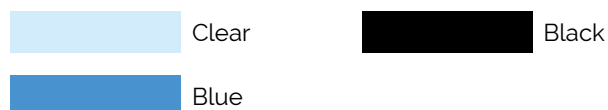

Available options

- 24 V solar power supply on a swivel stand (at the end of the tube).
- Anthracite coloured feet available as an option.
- OXEO contactless chlorinator option.
- Can be cut to size for steps (square or smooth finish).
- Solar or clear polycarbonate slats.
- Can be cut to size for filter blocks.
- Optional poolside safety strap loop.
- Remote control opening/closing or via Bluetooth system.
- GR VOL anti-leaf net (available in: grey, blue or green).
- Motor clutch.
- Easy plug/ remote control unit power supply with plug.

Examples of finishes

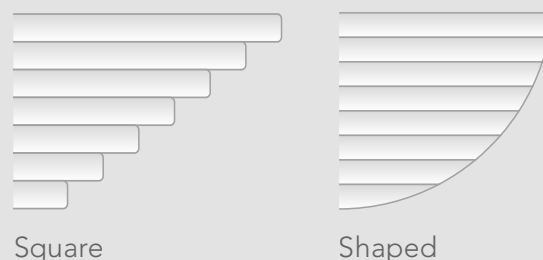

PVC BLADE COLOURS (3-year guarantee)



POLYCARBONATE SLAT COLOURS (5-year guarantee)

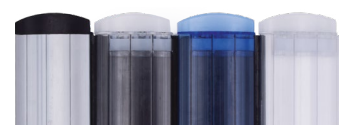

NB: Clear polycarbonate slats are for indoor use only. The blue and black slats heat the water. Grey slats do not heat the water.

UNDERWATER SHUTTER



A stylish and discreet cover. In addition to securing the pool, the underwater shutter frees up all the space around the pool to relax.



View the complete technical data sheet

Features

- Limits dirt, keeps the pool clean and prevents the growth of algae.
- Can be installed when the pool is built or added later on.
- Practical, stylish and discreet.
- Installed with a partition to separate the swimming area from the shutter storage area.
- Underwater motorised tube.
- Easy access to the mechanism hidden under the grating.
- Frees up space around the pool.

Technical specifications

- Underwater insulated motor and tube.
- Chlorinator control.
- Integrated end of travel limit switch.
- Wall-mounted standard version - Option: Corner block (submerged deck).
- PVC or wooden grating.

DIMENSIONS

- Slats: 1.7 cm thick.
- Minimum width: 3 m. Maximum width: 6m.
- Maximum surface area: 72m².

Opaque, waterproof, interlocking PVC slats

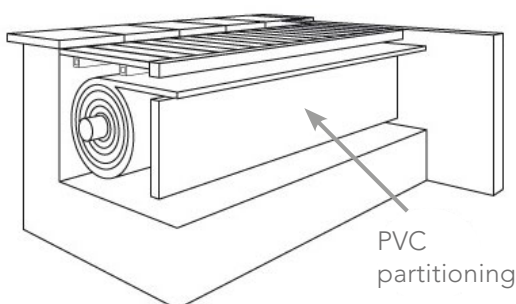

Available options

- + PVC partition (in white, sand or grey).
- + Corner block to create a submerged deck.
- + Aluminium beam.
- + PVC or wooden grating.
- + Solar or clear polycarbonate slats.
- + Can be cut to size for steps (square or smooth finish).
- + Can be cut to size for filter blocks.
- + Poolside safety strap loop.
- + Remote control opening/closing or via Bluetooth system.

Examples of finishes

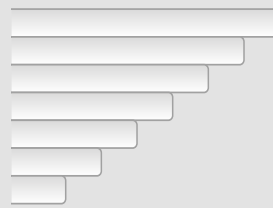

Square



Shaped

PVC BLADE COLOURS (3-year guarantee)



POLYCARBONATE SLAT COLOURS (5-year guarantee)



NB: Clear polycarbonate slats are for indoor use only. The blue and black slats heat the water. Grey slats do not heat the water.

END CAP COLOURS (polycarbonate only)



TOTAL UNDERWATER SHUTTER



This version of the underwater shutter frees up all the space both inside and outside the pool.



View the complete technical data sheet

Features

- Limits dirt, keeps the pool clean and prevents the growth of algae.
- Can be installed when the pool is built or added later on.
- Practical, stylish and discreet.
- Underwater casing to create a submerged deck, bench or staircase.
- Installed with a partition to separate the swimming area from the shutter storage area.
- Underwater motorised tube.
- Frees up space around the pool.

Technical specifications

- Underwater insulated motor and tube.
- Chlorinator control.
- Integrated end of travel limit switch.
- Wall-mounted finish only.
- Underwater grating in reinforced PVC or wood.

DIMENSIONS

- Slats: 1.7 cm thick.
- Minimum width: 3 m. Maximum width: 5m.
- Maximum surface area: 60m².
- Maximum depth of the grating: 30 cm under water.

Opaque, waterproof, interlocking PVC slats

END CAP COLOURS (polycarbonate only)



Available options

- + PVC partition.
- + Corner block.
- + Aluminium beam.
- + Wooden grating (Robinia or Brazilian hardwood).
- + Solar or clear polycarbonate slats.
- + Can be cut to size for steps (square or smooth finish).
- + Can be cut to size for filter blocks.
- + Poolside safety strap loop.
- + Remote control opening/closing or via Bluetooth system.
- + Cover grating (for reinforced PVC only).



PVC BLADE COLOURS (3-year guarantee)



POLYCARBONATE SLAT COLOURS (5-year guarantee)

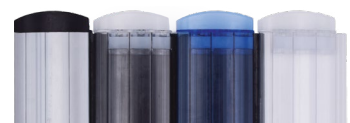

NB: Clear polycarbonate slats are for indoor use only. The blue and black slats heat the water. Grey slats do not heat the water.

Pool enclosures



CURVED ENCLOSURE



& POLY CARBON ATE



A simple and effective solution to protect your pool.



View the complete technical data sheet

Features

- Fitted without ground rails.
- Swivel opening with support bar.
- Easy to open and close.
- Wheeled system.
- Stackable panels.
- Increased safety thanks to its slight curvature, which allows it to support heavier loads per m².
- Safety knob with key lock.



Technical specifications

DIMENSIONS

- Up to 5.50m wide.
- Maximum width per element: 2.10m.
- Slightly curved in both directions (length and width).
- Support bars: 1.80m.

MATERIALS

- Qualicoat and Qualimarine certified powder-coated aluminium frame.
- 8mm honeycomb polycarbonate roofing.
- Polycarbonate with anti-UV and anti-yellowing treatment on both sides.
- Aluminium and stainless steel fixtures & fasteners.
- Front panels: 4 mm clear polycarbonate available in lengths from 4.90 m to 5.50 m.

Available options

- + Electric lifting system.
- + Low-profile adaptation for pool ends or overhangs.
- + Ladder attachment.

COLOURS

 Light grey RAL 7037

NÉO SMART RETRACTABLE ENCLOSURE



& POLYCARBONATE



The lowest retractable enclosure on the market.



View the complete technical data sheet

Features

- Overlapping structure for excellent air and water tightness.
- Extra low and ultra-discreet.
- Slides in both directions.
- Easy to use.
- Safety knob with key lock.



Technical specifications

DIMENSIONS

- Up to 5.30m internal width for the smallest element with a nominal height of only 12cm!
- Maximum width per element: 2.10m.

MATERIALS

- Qualicoat and Qualimarine certified powder-coated aluminium frame.
- 8mm honeycomb polycarbonate roofing and front panel.
- Solid polycarbonate side panels.
- Polycarbonate with anti-UV and anti-yellowing treatment on both sides.
- Aluminium and stainless steel fixtures & fasteners.



Available options

- + Discrete external motorisation ("largest element to smallest").
- + Clear front.
- + Low-profile adaptation for pool ends or overhangs.
- + Front panel cut-out (only possible on the largest element).

COLOURS



Light grey RAL 7037



Anthracite grey RAL 7016

NÉO 18 RETRACTABLE ENCLOSURE



& POLYCARBONATE



*A discreet and practical model.
Extremely easy to use.*



View the complete
technical data sheet

Features

- Overlapping structure for excellent air and water tightness.
- Discreet.
- Slides in both directions.
- Easy to use.
- Safety knob with key lock.

Technical specifications



DIMENSIONS

- Up to 5.80m internal width for the smallest element with a nominal height of 18cm.
- Maximum width per element: 2.10m.

MATERIALS

- Qualicoat and Qualimarine certified powder-coated aluminium frame.
- 8mm honeycomb polycarbonate roofing and front panel.
- Solid polycarbonate side panels.
- Polycarbonate with anti-UV and anti-yellowing treatment on both sides.
- Aluminium and stainless steel fixtures & fasteners.

COLOURS

-  Light grey RAL 7037
-  Anthracite grey RAL 7016



Available options

- + Discreet external motorisation.
- + Visio Sliding door® System (only on small frames).
- + Condensation-limiting air gap (only on large frames).
- + Clear front.
- + Removable front panel.

Also available in XXL

to fit non-standard pools - over 6m wide. For widths above 8.5m, you should opt for a 2-sided frame.

NÉO 30 RETRACTABLE ENCLOSURE



&
POLYCARBONATE



An elegant, low design that you can swim underneath.



View the complete
technical data sheet

Features

- Overlapping structure for excellent air and water tightness.
- Designed so that you can swim underneath.
- Slides in both directions.
- Easy to use.
- Safety knob with key lock.

Technical specifications

DIMENSIONS

- Up to 5.80m internal width for the smallest element with a nominal height of 30cm.
- Maximum width per element: 2.10m.

MATERIALS

- Qualicoat and Qualimarine certified powder-coated aluminium frame.
- 8mm honeycomb polycarbonate roofing and front panel.
- Solid polycarbonate side panels.
- Polycarbonate with anti-UV and anti-yellowing treatment on both sides.
- Aluminium and stainless steel fixtures & fasteners.

COLOURS



Light grey RAL 7037



Anthracite grey RAL 7016



Available options

- + Discreet external motorisation.
- + Visio Sliding door® System (only on small frames).
- + Condensation-limiting air gap.
- + Clear front.
- + Removable front panel.

Also available in XXL

to fit non-standard pools - over 6m wide. For widths above 8.5m, you should opt for a 2-sided frame.

NÉO 50 RETRACTABLE ENCLOSURE



& POLYCARBONATE



The highest enclosure in the Néo range. You can swim underneath it, even when it is closed.



View the complete technical data sheet

Features

- Overlapping structure for excellent air and water tightness.
- High enough to swim underneath, even when it is completely closed.
- Slides in both directions.
- Overlapping structure for excellent air and water tightness.
- Easy to use.
- Safety knob with key lock.

Technical specifications



DIMENSIONS

- Up to 5.80m internal width for the smallest element with a nominal height of 50cm.
- Maximum width per element: 2.10m.

MATERIALS

- Qualicoat and Qualimarine certified powder-coated aluminium frame.
- 8mm honeycomb polycarbonate roofing and front panel.
- Solid polycarbonate side panels.
- Polycarbonate with anti-UV and anti-yellowing treatment on both sides.
- Aluminium and stainless steel fixtures & fasteners.

COLOURS

-  Light grey RAL 7037
-  Anthracite grey RAL 7016



Available options

- + Discreet external motorisation.
- + Visio Sliding door® System (only on small frames).
- + Condensation-limiting air gap.
- + Clear front.
- + Removable front panel.

Also available in XXL

to fit non-standard pools - over 6m wide. For widths above 8.5m, you should opt for a 2-sided frame.

ELYO RETRACTABLE ENCLOSURE



*An enclosure specially designed
for professional use.*



View the complete
technical data sheet

Features

- Easy-to-install pre-assembled enclosure.
- Overlapping structure for excellent air and water tightness.
- Discreet.
- Slides in both directions.
- Easy to use.
- Safety knob with key lock.

Technical specifications

DIMENSIONS

- Available in 3 nominal heights: 18, 30 and 50 cm.
- Up to 5.80m internal width for the smallest element.
- Maximum width per element: 2.10m.

MATERIALS

- Qualicoat and Qualimarine certified powder-coated aluminium frame.
- 8mm honeycomb polycarbonate roofing.
- 8mm honeycomb polycarbonate front panel.
- Solid polycarbonate side panels.
- Polycarbonate with anti-UV and anti-yellowing treatment on both sides.
- Aluminium and stainless steel fixtures & fasteners.
- Omega guide rail (round rail with recessed wheels).

COLOURS

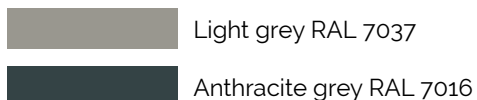

+ 2 additional
exclusive colours

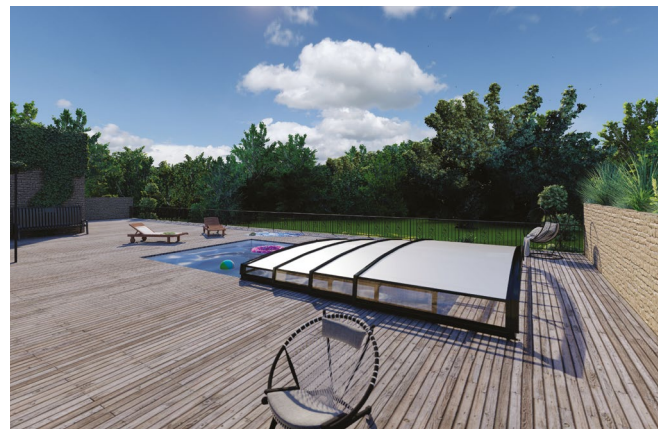

Available options

- + Discreet external motorisation.
- + Condensation-limiting air gap (only on large frames).
- + Clear front.
- + Removable front panel.

R-DESIGN MEDIUM HEIGHT ENCLOSURE



This enclosure combines the comfort of a high enclosure with the discrete design of a low enclosure.



View the complete technical data sheet

Features

- No planning permission required* (less than 1.80m high at its highest point).
- Contemporary design.
- Fully retractable.
- Easy to open and close.
- Takes up very little floor space.
- Completely safe and secure.
- Allows you to enjoy your pool all year round.



Technical specifications

DIMENSIONS

- Up to 10m (anti-lift rails must be fitted to enclosures longer than 8m**).
- Maximum width per element: 2.15m.
- Maximum ridge height: 1.80m.

MATERIALS

- Qualicoat and Qualimarine certified powder-coated aluminium frame.
- 8mm honeycomb polycarbonate roofing.
- Solid polycarbonate front + side panels.
- Polycarbonate with anti-UV and anti-yellowing treatment on both sides.
- Aluminium and stainless steel fixtures & fasteners on both sides.



Available options

- + External motorisation.
- + Fixed glass front.
- + 1 or 2-leaf sliding door.
- + Folding doors.
- + Sliding door or window.
- + Central opening.
- + Side panel in 4mm safety glass.

COLOURS



Anthracite grey RAL 7016

*Subject to local planning regulations. **Width of the largest element.

R-DESIGN HIGH RETRACTABLE ENCLOSURE



& POLYCARBONATE



A great space that protects your pool. Allows you to enjoy your pool all year round.



View the complete technical data sheet

Features

- Allows you to enjoy your pool all year round.
- Fits in perfectly with the environment.
- Fully retractable.
- Easy to open and close.
- Takes up very little floor space.
- Completely safe and secure.



Technical specifications

DIMENSIONS

- Up to 10m (anti-lift rails must be fitted to enclosures longer than 8m*).
- Maximum width per element: 2.15m.

MATERIALS

- Qualicoat and Qualimarine certified powder-coated aluminium frame.
- Honeycombed polycarbonate roofing.
- Clear polycarbonate front panels and side panels.
- Solid polycarbonate side panels.
- Polycarbonate with anti-UV and anti-yellowing treatment on both sides.
- Aluminium and stainless steel fixtures & fasteners.



Available options

- + External motorisation.
- + Fixed glass front.
- + 1 or 2-leaf sliding door.
- + Folding doors.
- + Sliding door.
- + Central opening.
- + Side panel in 4mm safety glass.

COLOURS



Anthracite grey RAL 7016

*Width of the largest element.

1 OR 2 SIDES LEAN-TO POOL ENCLOSURE



Creates a seamless transition between the house and the pool area.



View the complete technical data sheet

Features

- A real extension for your home.
- Running perpendicular to your house, this enclosure slides easily to allow access to the pool.
- Without ground rails (only for the staggered-stacked version for the lean-to enclosure).
- Key lock.
- Excellent thermal insulation.



Technical specifications

DIMENSIONS

- Available in 1-panel and 2-panel versions (only for lean-to version).
- Up to 6.80 m wide.
- Maximum width per element: 2.18m.
- 1 sliding door on each side.
- Anti-lift rail.

MATERIALS



- Qualicoat and Qualimarine certified powder-coated aluminium frame.
- 6060 T5 Aluminium.
- 8mm honeycomb polycarbonate roofing.
- Clear polycarbonate front panels and side panels.
- Polycarbonate with anti-UV and anti-yellowing treatment on both sides.
- Aluminium and stainless steel fixtures & fasteners.



Available options

- + Fixed front panel.
- + Folding door at the back or front.
- + Side door or window.
- + Single or double doors.
- + Extension rails.

COLOURS

-  Aluminium grey RAL 9007
-  Anthracite grey RAL 7016

FIXED ENCLOSURE



& POLYCARBONATE



A stylish, modular enclosure that creates a whole new living space.



View the complete technical data sheet

Features

- Allows you to enjoy your pool all year round.
- Highly efficient thermal protection.
- 1 sliding door on each side.
- Available as a lean-to or freestanding enclosure.
- Sturdy and stylish.



Technical specifications

DIMENSIONS

- Maximum width: 10.80m

MATERIALS

- Qualicoat and Qualimarine certified powder-coated lightweight aluminium frame.
- 8mm honeycomb polycarbonate roofing
- 3mm solid polycarbonate side panels.
- 4mm solid polycarbonate front panel.
- All polycarbonate elements are treated with an anti-UV treatment on both sides



Available options

- + Double sliding door on the front panel.
- + Folding door at the back or front.
- + Single or double connector profiles.

COLOURS



Aluminium grey RAL 9007G (granite)



Anthracite grey RAL 7016G (granite)

POOLDECK SLIDING PATIO



3 in 1: patio, decking & pool protection.



View the complete technical data sheet

Features

- Space optimisation.
- Suitable for almost any pool.
- Impressive design.
- Prevents water evaporation and heat loss.
- Extremely easy to use.
- Safe & secure locking.
- 1 or 2 sliding decks (depending on the size of the pool).



Technical specifications

DIMENSIONS

- Available with 1 or 2 sliding decks.
- Maximum distance: 6m (distance between the 2 guide rails).

MATERIALS

- 6060T6 aluminium frame.
- Stainless steel wheels.
- Stainless steel fasteners.

Available options

- + External solar-powered motorisation.
- + Oxeo control unit.
- + Wooden decking - 3 colours available: Kebony / Thermofrêne / Thermopin.

WOOD COLOURS

À LA POSE	1 AN	2 ANS	Kebony	
À LA POSE	6 MOIS	1 AN		Thermofrêne
À LA POSE	6 MOIS	1 AN		Thermopin

Heat pumps

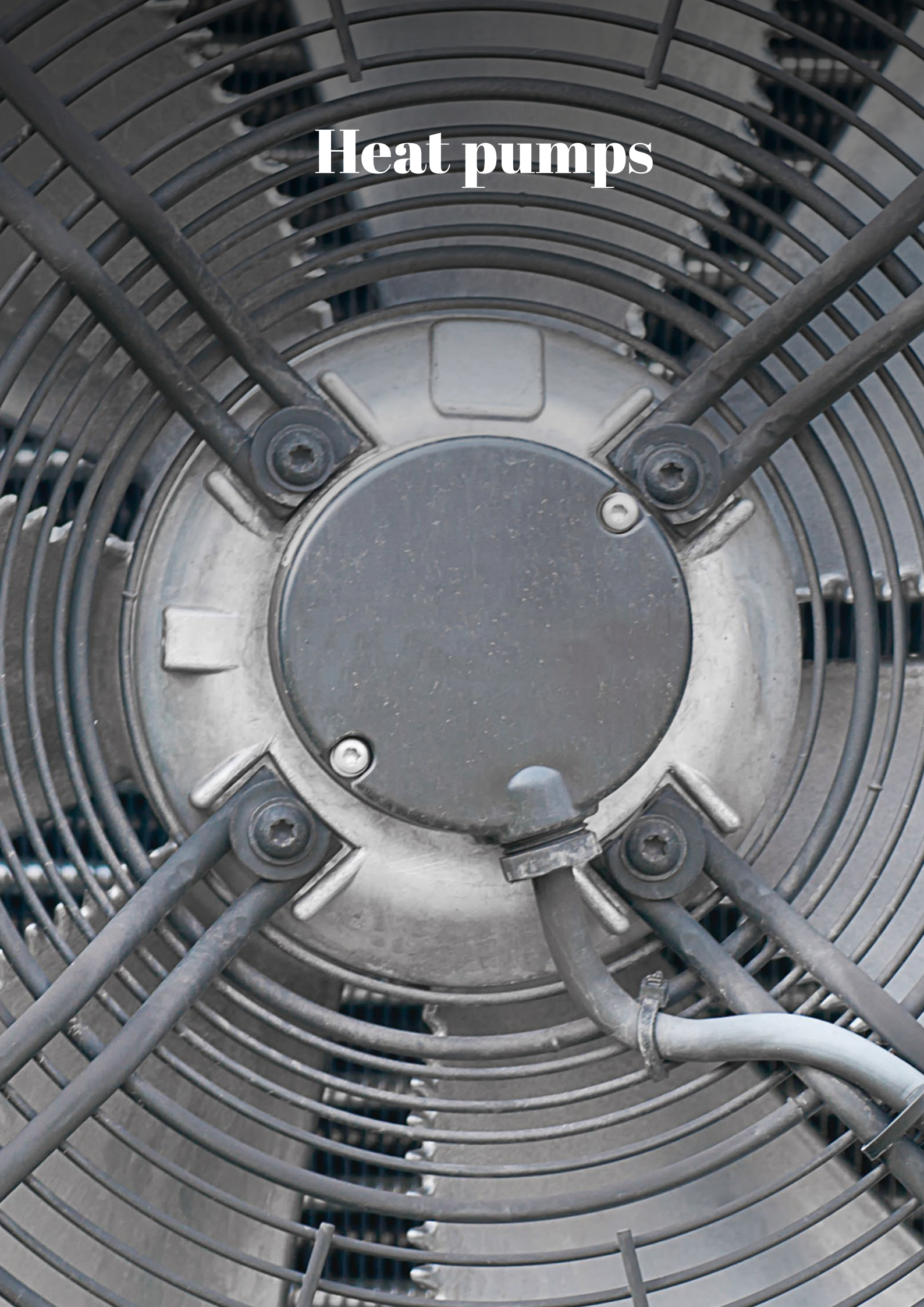

PRIMYPAC HEAT PUMPS



The perfect blend of high performance and cost effectiveness for pools up to 75 m³.



Features

- Heat pump for pools up to 75 m³.
- Powerful, economical and quiet.
- Eco-label.
- Equipped with an anti-vibration shock mount.

Models

- 55 (15 to 30 m³).
- 100 (30 to 50 m³).
- 130 (50 to 75 m³).



View the complete technical data sheet

Technical specifications

MODEL	PRIMYPAC 55 - Mono	PRIMYPAC 100 - Mono	PRIMYPAC 130 - Mono
Recommended pool volume (1)	15 to 30 m ³	30 to 50 m ³	50 to 75 m ³
Power output (KW) (2)	6.60	9.50	12.50
Power consumption (KW) (2)	1.08	1.57	2.04
C.O.P (Coefficient of Performance) (2)	6.10	6.05	6.12
Power output (KW) (3)	4.65	6.56	9.56
Power consumption (KW) (3)	1.02	1.46	2.09
C.O.P (Coefficient of Performance) (3)	4.55	4.48	4.58
Compressor	Rotary	Rotary	Rotary
Noise level at 10 m (dbA)	35	37	38
Noise level at 1 m (dbA)	45	47	48
Outlet diameter (mm)	50	50	50
Water flow rate (m ³ /h)	2-4	4-6	6-8
Refrigerant	R410A	R410A	R410A
Heat pump dimensions (LXWXH)	800 x 300 x 545	942 x 425 x 720	942 x 425 x 720
Heat pump weight (kg)	39	51	58
Packaging dimensions (LxWxH)	885 x 350 x 600	1010 x 460 x 851	1010 x 460 x 851
Weight with packaging (kg)	42	55	62

(1) Average values estimated for a private pool equipped with an isothermal cover from 15 May to 15 September. (2) Heating capacity when the ambient air temperature is 27°C - water temperature: 27°C. (3) Heating capacity with an ambient air temperature of 15°C - water temperature: 26°C.

ELYTPAC HEAT PUMPS FULL INVERTER PUMP



This powerful and reversible unit can be used in all seasons for pools up to 120 m³.



Features

- Heat pump for pools up to 120 m³.
- Powerful, economical and quiet.
- Consistent performance in fluctuating temperatures thanks to the rotary & scroll compressors.
- Automatic heat pump defrosting, to as low as -10°C.
- Eco-label.
- Reversible.
- Removable display.
- Equipped with an anti-vibration shock mount.

Models

- 55 (15 to 30 m³).
- 100 (30 to 50 m³).
- 130 (50 to 75 m³).
- 180 (75 to 100 m³).
- 220 (90 to 120 m³).



View the complete technical data sheet

Titanium exchanger/PVC body

Technical specifications

MODEL	ELYTPAC 55 - Mono	ELYTPAC 100 - Mono	ELYTPAC 130 - Mono	ELYTPAC 180 - Mono	ELYTPAC 220 - Mono
Recommended pool volume (1)	15 to 30 m ³	30 to 50 m ³	50 to 75 m ³	75 to 100 m ³	90 to 120 m ³
Voltage (V)	220-240	220-240	220-240	220-240	220-240
Max. input current (A)	7.10	10.49	12.23	17.50	24.50
Power output (KW) (2)	6.1	9.50	12.50	18.80	22
Power consumption (KW) (2)	1.08	1.57	2.04	3.09	3.55
Power output (KW) (3)	4.65	6.56	9.56	13.80	15.68
Power consumption (KW) (3)	1.02	1.46	2.09	3.07	3.34
Power output (KW) (4)	2.15	3.12	4.55	6.57	9.10
Power consumption (KW) (4)	0.78	1.16	1.64	2.45	3.36
Power output (KW) (5)	3.38	5.12	7.46	10.76	12.23
Power consumption (KW) (5)	1.12	1.95	2.82	4.12	4.69
Pipe diameter (mm)	50	50	50	50	50
Recommended water flow rate (m ³ /h)	2.8	4.8	6.2	7.8	8
Compressor	Rotary	Rotary	Scroll	Scroll	Scroll
Heat exchanger	Titanium exchanger/ PVC body	itanium exchanger/ PVC body	itanium exchanger/ PVC body	itanium exchanger/ PVC body	itanium exchanger/ PVC body
Noise level at 10 m (dba)	35	37	38	40	41
Heat pump dimensions (LXWXH)	800 x 355 x 555	942 x 425 x 720	942 x 425 x 720	960 x 445 x 815	1050 x 412 x 703
Heat pump weight (kg)	39	51	58	75	105
Packaging dimensions (LxWxH)	885x300x545	1010x460x851	1010x460x851	988x398x1010	1112x465x853
Weight with packaging (kg)	42	55	62	79	109

(1) Average values estimated for a private pool equipped with an isothermal cover from 15 May to 15 September. (2) Heating capacity when the ambient air temperature is 27°C - water temperature: 27°C. (3) Heating capacity with an ambient air temperature of 15°C - water temperature: 26°C. (4) Heating capacity with an ambient air temperature of -10°C - water temperature: 24°C. (5) Cooling capacity with an ambient air temperature of 35°C - water temperature: 27°C.



Outdoor

PERGOLAS



BIOCLIMATIC PERGOLA WITH ADJUSTABLE SLATS



The perfect solution to keep the sun out in the summer and let in light and warmth in the winter.

Features

- Suitable for all types of patios.
- Keeps the sun out in the summer and lets in light in the winter.
- Can be equipped with an automated climate control system with rain or wind sensors, for automatic closing & opening.
- The air circulation between the slats provides natural ventilation.
- The water drainage system is discretely integrated into each post.
- Complete with peripheral gutters that drain directly into the posts (no visible rainwater downspouts).



Technical specifications

- The slats can be tilted from 0° to 135° with 4 pre-set positions.
- 155x155mm aluminium posts.
- Standard height: up to 2,500mm (max: 3,000mm).

DIMENSIONS

- Up to 6m long x 4.5m deep.
- An additional module is required for anything larger than these dimensions.

MATERIALS

- Qualicoat & Qualimarine certified powder-coated aluminium frame (aluminium guaranteed for 10 years and powder coating guaranteed for 10 years - class II).
- Stainless steel fasteners and ground plates.







SLAT COLOURS

 Matt White RAL 9016

Available options

- + Overhanging roof
- + Offset post
- + Integrated spotlights or LED strip lighting
- + Motorised roller blinds
- + Glazed frame
- + Fixed solid/ openwork / mixed privacy screen
- + Sliding privacy screen with adjustable slats
- + Sliding glass

FRAME COLOURS

	Glossy white RAL 9010		Textured sanded black SP027
	Textured light ivory SP057		Textured anthracite grey SP055
	Textured frosted grey SP004		Textured anthracite grey SP023

BIOCLIMATIC PERGOLA WITH OPENING ROOF



Sliding panels to add light or shade.

Features

- The only pergola with a fully opening modular roof.
- Contemporary design.
- Easy to use, whether manual or motorised.
- Suitable for all types of patios.
- Available in lean-to or freestanding versions.
- Peripheral gutters with 360 mm decorative cover for rainwater drainage.

Technical specifications

- 165x165mm aluminium posts.
- 4 frames (2 fixed outer frames + 2 retractable central frames).

DIMENSIONS

- Standard height: up to 2,500mm (max: 3,000mm).
- Central post required for lengths over 6m.

MATERIALS

- 6060T5 Qualicoat & Qualimarine certified powder-coated aluminium frame (aluminium guaranteed for 10 years and powder coating guaranteed for 10 years - class II).
- 4mm clear polycarbonate roofing or 8mm honeycomb roofing.
- Polycarbonate with anti-UV treatment on both sides, guaranteed for 10 years against yellowing, weakening and hailstone damage.
- Stainless steel screws and aluminium mounting plate.

FRAME COLOURS

	Glossy white RAL 9010		Textured sanded black SP027
	Textured light ivory SP057		Textured anthracite grey SP055
	Textured frosted grey SP004		Textured anthracite grey SP023



Available options

- + Solid or openwork Dibond® sunblind.
- + Fixed solid/ openwork / mixed privacy screen.
- + Sliding privacy screen with adjustable slats
- + 10mm sliding tempered glass panel.
- + Somfy tubular roof motorisation.
- + LED lighting.
- + Electric roller blinds.
- + Glazed frame
- + Offset post

BIOCLIMATIC PERGOLA WITH VARIABLE TINT FIXED ROOF



A fixed-roof pergola with variable tint, which adapts to your needs in terms of light and heat

Features

- Pergola with Sageglass® variable-tint glazing
- This innovative roofing system controls the amount of heat and light entering through the roof
- With 4 tint variations to control heat and glare.
- Peripheral gutter for rainwater drainage, which drains directly into the Ø80mm downspouts.

Technical specifications

- 130x50mm posts fixed to the ground using base plates.
- The roof panels are fixed with glazing beads for excellent wind resistance.

DIMENSIONS

- Custom sizes - up to 8m long x 4.5m deep.
- Standard height: up to 2,400mm (max: 3,000mm).

MATERIALS

- 6060T5 Qualicoat and Qualimarine certified powder-coated aluminium frame, 120 microns
- Roofing equipped with Sageglass® technology
- Robust wall connection with triple sealing system (flashing, flashing seal and water run-off profile)

FRAME COLOURS

	Glossy white RAL 9010		Textured sanded black SP027
	Textured light ivory SP057		Textured anthracite grey SP055
	Textured frosted grey SP004		Textured anthracite grey SP023



Available options

- + Change the roof tint depending on the desired level of sun protection
- + Integrated LED spotlights
- + Façade screen or blind
- + Solar sensor
- + Glazed frame
- + Fixed solid/ openwork / mixed privacy screen
- + Sliding privacy screen with adjustable slats
- + Sliding glass

Carports



CARPORT



The perfect solution for protecting your vehicles.

Features

- Made-to-measure.
- Lean-to or freestanding.
- Stylish and contemporary design.
- Protect your vehicle from the weather and the elements, such as sun and hail.
- Does not rust.

Technical specifications

- 165x165mm aluminium posts.
- Rainwater collection system with peripheral gutter and 360 mm high decorative cover.

DIMENSIONS

- Up to 8m long x 5m deep.
- Standard height: up to 2,500mm (max: 3,000mm).
- Extra post required for lengths over 6m.
- An additional module is required for anything larger than these dimensions.

MATERIALS

- 6060T5 Qualicoat & Qualimarine certified powder-coated aluminium frame (aluminium guaranteed for 10 years and powder coating guaranteed for 10 years - class II).
- Freestanding, 63 mm thick sandwich panels, centre-to-centre widths: 1200 mm & gutters.
- Rainwater drainage built into the posts (no visible downspouts).
- Stainless steel screws and aluminium mounting plate.

PANNEL COLOURS



 Textured matt white on the inside
Glossy white on the outside



Available options

- + Pegaso LED lighting strip.
- + Fixed privacy screen.
- + Offset post

FRAME COLOURS

	Glossy white RAL 9010		Textured sanded black SP027
	Textured light ivory SP057		Textured anthracite grey SP055
	Textured frosted grey SP004		Textured anthracite grey SP023

Accessories



MOTORISED ROLLING UP



Features

- Makes rolling up the safety cover a breeze.
- The handle helps you guide the roll-up all the way to the end (no rubbing on the poolside and prevents the bars from falling down).
- Recommended for pools with internal dimensions greater than 4.50 x 9 m.
- Suitable for our range of covers (Sécu Classic, Sécu Basic and Sécu+) as well as a wide range of covers available on the market.
- Easy to operate - at the touch of a button.
- The Rolling-Up system is powered by a 12V rechargeable battery.
- This means that you can move around the pool in complete safety without any risk of electric shock.
- The square drive is located on the left by default.
- Unroll using unrolling strap.
- Strong and reliable thanks to its steel casing.

Available options

- + Square drive on the right.



MANUAL CRANK HANDLE



Features

- When it comes to covering and uncovering the pool, our safety cover systems are equipped with a manual crank handle for rolling up the cover and an unrolling strap for easy unrolling.



ECO ROLLER FOR POOLS UP TO 4 M

Features

- For below-ground pools.
- Tube external diameter: 80 mm (81 - 3/170).
- T-shaped feet.
- Double-ended swivel end cord.



ROLLER FOR POOLS FROM 3 TO 5 M

Features

- For below-ground pools.
- Tube external diameter: 80 mm (81 - 3/215).
- U-shaped feet.
- Double-ended swivel end cord.



ROLLER FOR POOLS UP TO 6 M

Features

- For below-ground pools.
- Tube external diameter: 102 mm (102 - 3/245).
- T-shaped feet.
- Double-ended swivel end cord.



SPECIAL DESIGN FOR ABOVE-GROUND POOLS

Features

- Roller specially designed for above ground pools
- For pools up to 6.15 m
- Heavy duty plastic fixings for use on above ground pools with a solid pool edge.
- 7 x 105cm aluminium tubes + 1 x 20cm aluminium tube.
- 1 crank handle.



RATCHET TENSIONER

ACCLIQ



SÉCU + RATCHET TENSIONER

ACCLIQSEC+



TENSIONER SPRING

ACDYN



HEAVY-DUTY STRAP

ACSANGLUX



SAFETYSTRAP WITH ATTACHMENT LOOPS

ACSANGD



SÉCU + RATCHET STRAP WITH ATTACHMENT RINGS

ACSANGD+



LOOSE STRAP

ACSANGGAN



SUPPORT STRAP

ACKITSOUT

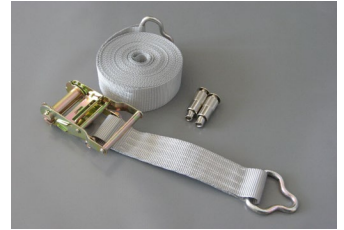

OUTER EDGE BUNGEE CORD

ACSANML



V BUNGEE CORD WITH FLAT ATTACHMENT END

ACPLAQUET (attachment end only)
ACSANVPLAQUET

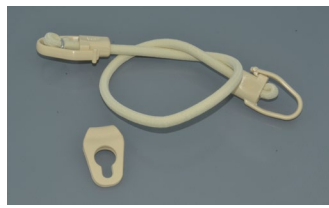

VBUNGEE CORD WITH PLASTIC HOOK (Sécuritis éco and above ground)

ACSANVECO



V BUNGEE CORD WITH STEEL HOOK

ACSANCROACIER



CABICLIC BUNGEE

ACCAB

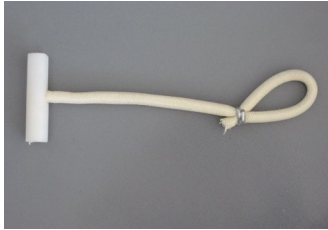

STAINLESSSTEEL RETRACTABLE PIN (Ø12 MM)

ACPITESC



STAINLESSSTEEL RETRACTABLE PIN (Ø18 MM)

ACPITESC+



RETRACTABLE PIN FOR WOODEN DECKING

ACPITBOIS



STAINLESS STEEL GROUND PEG

ACPITCROS

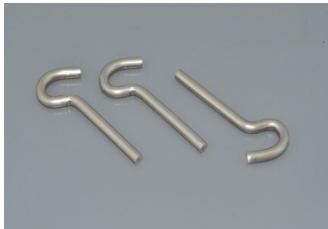

LAWN PEG

ACPITGAZ



PLASTIC HOOK

ACCROPLAST



STAINLESS STEEL HOOK

ACCROINOX



RUNNERS (Sécu + and bar models)

ACKITPAT



WATER TUBES (2LM)

ACBOUEAU

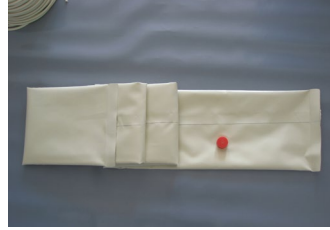

METAL EYELETS + INSTALLATION KIT

ACKITEMPOEIL



PLASTIC EYELETS

ACOEILPLAST



REPAIR KIT

ACKITREPA



DOUBLE-ENDED SWIVEL END CORD

ACSANENR

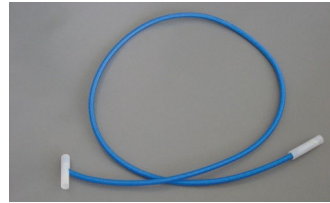

RETRACTABLE STRAP WITH CROCODILE CLIPS

ACSANENRCROCO



BATTERY

ACRUPBAT

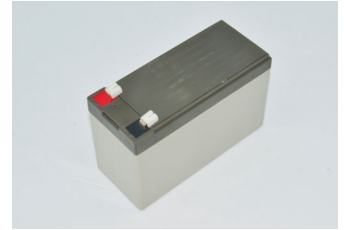

STRAP

ACBUSANGLET



PROTECTIVE COVER

ACBUBACHET



LEAF COLLECTOR FOR BUBBLE COVER

ACBOUFEUIL

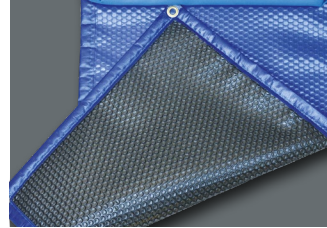

MANUAL CRANK HANDLE

ACMANIV



COVERWOOD CRANK HANDLE

ACBAVOL



LOAD BAR

ACBACHAR



ROLL-UP BAR

ACBAENR



ROLL-UP SQUARE DRIVE

ACBACARR



ANTI-ABRASION STRIPS

ACANTIABRA

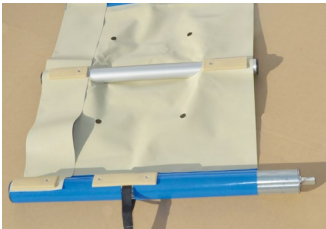

PUSHBUTTON FOR ROLLING UP SYSTEM

ACBOURUP



ROLLING UP SYSTEM CHARGER

ACRUPCHARG



SHUTTER RESET BUTTON

ACVRRESET



SHUTTERS

END PIECES FOR PVC-POLYCARBONATE SHUTTER SLATS

ACVRAIL300BL (white)
ACVRAIL300COU (colour)



EXTENSIONS FOR PVC-POLYCARBONATE SHUTTER SLATS

ACVRRALL20BL (white)
ACVRRALL20COU (colour)

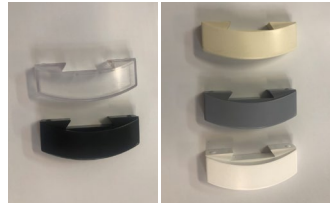

SHUTTER KEY

ACVRCLE



SHUTTER KEY + LOCK

ACVRBARILLCLE



SHUTTER SAFETY STRAP WITH RELEASE BUCKLE

ACVRBOUCL



LOOP WITH STRAP FOR THE SHUTTER TUBE

ACVRBOUCLSANG



POOLSIDE SAFETY STRAP LOOP

ACVRPASSANG



CONTACT KEY SWITCH

(contactor + bracket)

ACVRCOMMU
(version with 2 contactors)
ACVRCOMMU1
(version with 1 contactor)



OXEO CONTROL UNIT

ACCOFASSEROXEO



BLUETOOTH SYSTEM

ACVRTELECOMBL



POOL ENCLOSURE

SAFETY KNOB

SAFETY WHEEL



GREY KNOB

DMT KNOB



60 MM WOODEN SCREW PLUG + 10X20 SET SCREW

CHM10X60



30 MM SCREW PLUG FOR WOOD + 10X10 SET SCREW

CHM10X30



PADDED SEAL

SWJ05



SCREW COVER

SWQ262



SCREW COVER

SWQ7042



FIND ALL OUR SPARE PARTS IN OUR ONLINE SHOP
BOUTIQUE.AZENCO.FR

AZENCO a partner you can trust



REGISTERING ORDERS, TECHNICAL QUESTIONS, ADMINISTRATIVE FORMALITIES, AFTER-SALES SERVICE & FOLLOW-UP..

The technician handling your account becomes your dedicated contact person!



A SALES SUPPORT KIT

We provide you with various marketing materials.

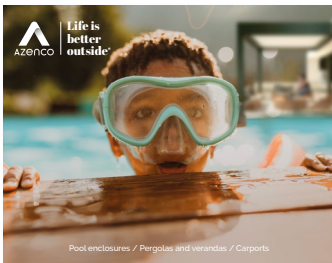

GENERAL CATALOGUE

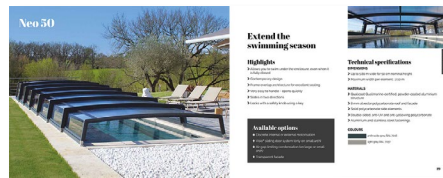

POS



TECHNICAL DATA SHEETS

Azenco is already present
in many countries

France
Belgium
Portugal
Sweden
Denmark
Italy
Algeria
Switzerland
Luxembourg

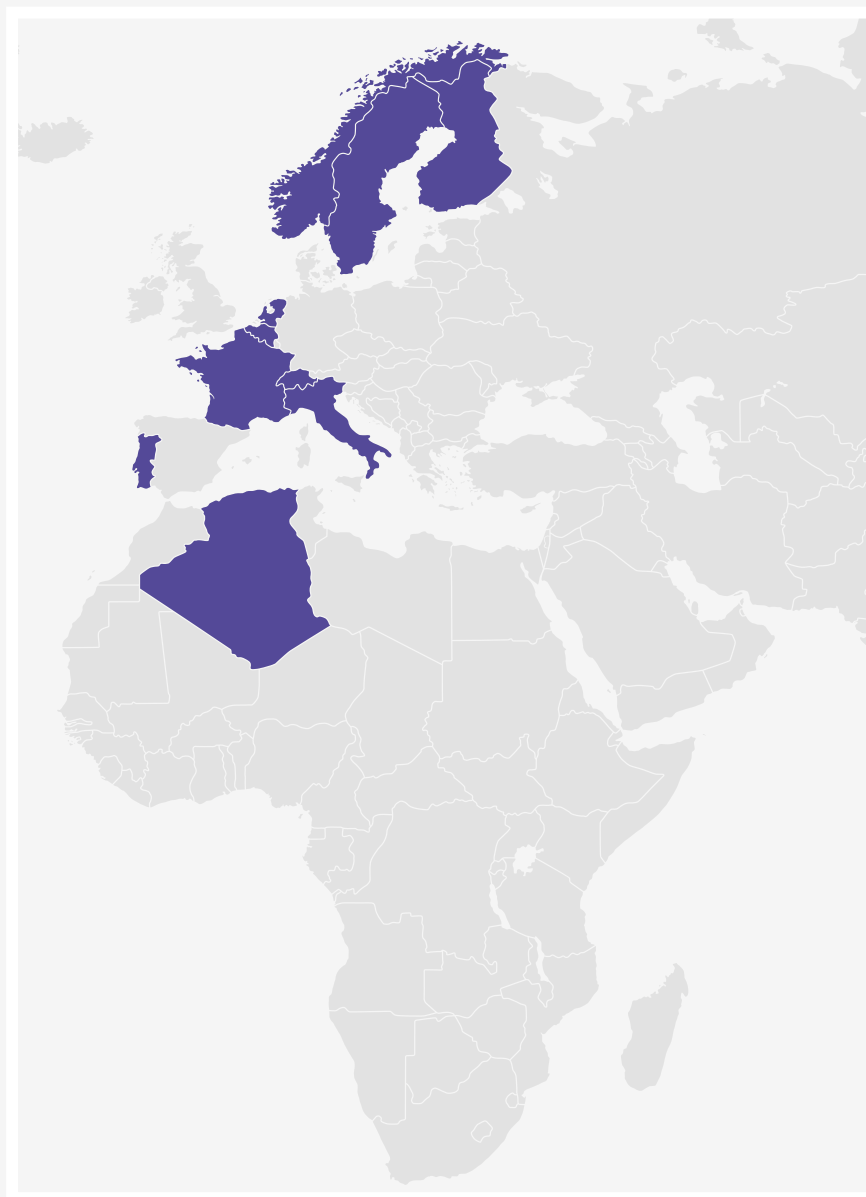

CONTACT US
adv.export@azenco.fr

azenco.fr
+33 (0)7 86 63 68 02



ZA de Masquère
31220 Cazères
FRANCE